

3" DIAL BACK CONNECTED BIMETAL "E" SERIES - MODEL 3BKE

STANDARD FEATURES

- 3" dial size
- 2 1/2", 4" and 6" stems only
- All welded 304 stainless steel construction
- Silicone dampened bimetal element
- Accurate to 1% per ASME B40.3
- External recalibration adjustment
- Anti-parallax dial
- Sealed to exclude dust, dirt, and moisture
- Over-range protection is 50% up to 500°F (10% above 500F)
- Fully gasketed glass lens

See page 20 for thermowells.



MODEL 3BKE ▶
3" Dial

TEMPERATURE RANGES

CODE	FAHRENHEIT
02	-40/120°F
03	0/150°F
04	0/200°F
05	0/250°F
06	20/240°F
07	25/125°F
09	50/300°F
10	50/400°F
11	50/500°F

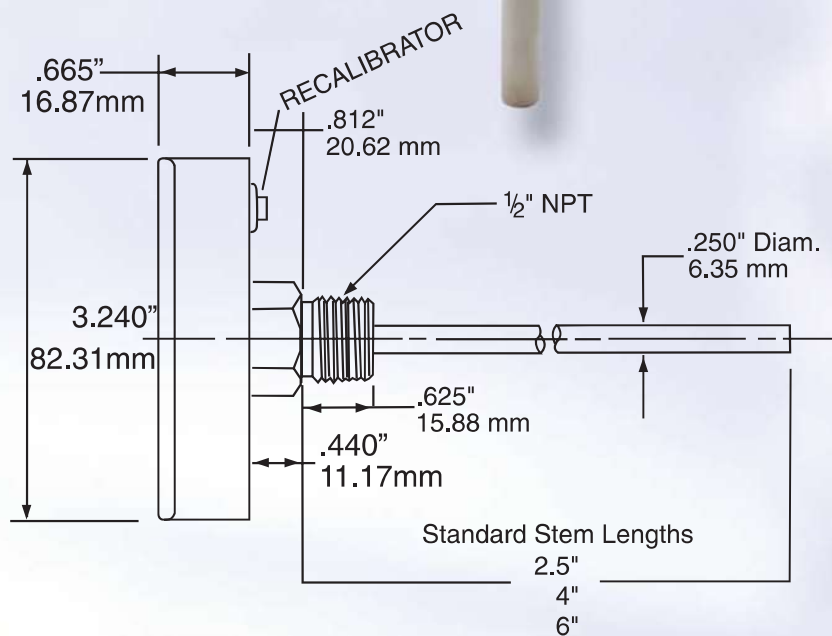

HOW TO ORDER - PLEASE SPECIFY THE FOLLOWING:

MODEL #	STEM LENGTH	"E" SERIES	RANGE
3BK	02 = 2 1/2" stem 06 = 6" stem 04 = 4" stem	E	2 digit code from table